

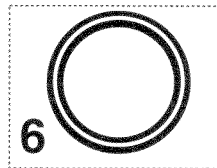

A/ZB328D.Z

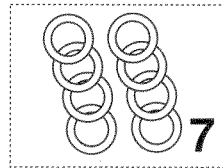

REP	DESIGNATION	QTE	REP.V.E
1 -	COUVERCLE POMPE	1	282
2 -	PLOMB THERMO RETRACT	1	381B
3 -	JOINT TOR COUVERCLE	1	283
4 -	JOINT TORIQUE	4	293-295
5 -	RONDELLE VIS SORTIE	2	336
6 -	JOINT A LEVRES	1	169
7 -	RONDELLE JOINT	8	85

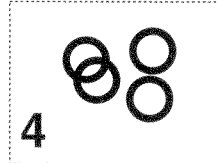
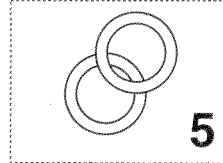
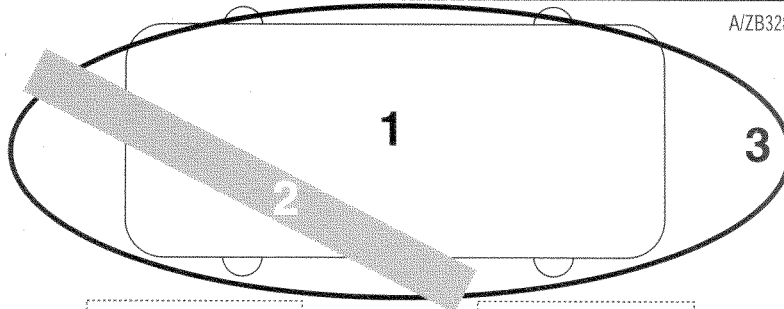
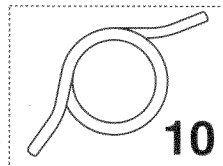
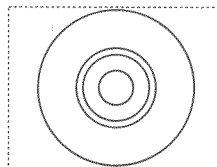
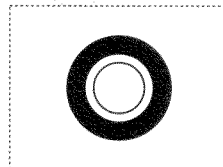

8 -	KIT PROTEGE POUSS	1	175
9 -	COUPELLE AXE VITESSE	1	298
10 -	RESSORT LEVIER VIT	1	299